



Making Your World
A Little Easier.™

Use And Care

G U I D E



A Note to You	2
Dishwasher Safety	3
Parts and Features	4
Starting Your Dishwasher	6
Loading Your Dishwasher	8
Using the Dispensers	11
Setting the Controls	13
Selecting a wash cycle	13
Canceling a cycle	14
Selecting cycle options	14
Changing a cycle setting ...	15
Adding an item during a cycle	15
Washing Special Items	16
Connecting a Portable Dishwasher	17
Caring for Your Dishwasher	20
Saving Energy	24
Solving Common Dishwashing Problems	25
Troubleshooting	28
Requesting Assistance or Service	29
Index	30
Warranty	32
1-800-253-1301	
Call our Consumer Assistance Center with questions or comments.	

DISHWASHER MODEL SERIES 400, 800, 806, 810, 830, 840

PART NO. 3376815 Rev. A

1-97

A Note to You

Thank you for buying a Whirlpool® appliance.

Because your life is getting busier and more complicated, WHIRLPOOL dishwashers are easy to use, save time, and help you manage your home better. To ensure you enjoy years of trouble-free operation, we developed this Use and Care Guide. It contains valuable information about how to operate and maintain your appliance properly and safely. Please read it carefully.

Also, please complete and mail the Ownership Registration Card provided with your appliance. This card helps us notify you about any new information on your appliance.

Please record your model's information.

Whenever you call to request service for your appliance, you need to know your complete model number and serial number. You can find this information on the model and serial number label (See the "Parts and Features" section).

Please also record the purchase date of your appliance and your dealer's name, address, and telephone number.

Model Number _____

Serial Number _____

Purchase Date _____

Dealer Name _____

Dealer Address _____

Dealer Phone _____

Keep this book and the sales slip together in a safe place for future reference.

**Our Consumer Assistance
Center number is toll-free.**

1-800-253-1301

Help us help you

Please:

- Have your dishwasher installed by a qualified installer.
- Install where dishwasher is protected from the elements.
- Install and level dishwasher on a floor that will hold the weight, and in an area suitable for its size and use.
- Properly connect dishwasher to electricity, water, and drain.*
- Remove all shipping plugs from hoses and connectors (such as the cap on the drain outlet) before installing.*
- Remove all hang tags and temporary labels.
- Make sure dishwasher is not used by anyone unable to operate it properly.
- Properly maintain dishwasher. See the "Caring for Your Dishwasher" section.

* See Installation Instructions for complete information.

Dishwasher Safety

Your safety is important to us.

This guide contains safety symbols and statements. Please pay special attention to these symbols and follow any instructions given. Here is a brief explanation of the use of the symbol.



This symbol alerts you to hazards such as fire, electrical shock, or other injuries.

IMPORTANT SAFETY INSTRUCTIONS

WARNING – When using the dishwasher, follow basic precautions, including the following:

- Read all instructions before using the dishwasher.
- Use the dishwasher only for its intended function.
- Use only detergents or rinse agents recommended for use in a dishwasher and keep them out of the reach of children.
- When loading items to be washed:
 - 1) Locate sharp items so that they are not likely to damage the door seal; and
 - 2) Load sharp knives with the handles up to reduce the risk of cut-type injuries.
- Do not wash plastic items unless they are marked "dishwasher safe" or the equivalent. For plastic items not so marked, check the manufacturer's recommendations.
- Do not touch the heating element during or immediately after use.
- Do not operate the dishwasher unless all enclosure panels are properly in place.
- Do not tamper with controls.
- Do not abuse, sit on, or stand on the door or dish racks of the dishwasher.
- To reduce the risk of injury, do not allow children to play in or on the dishwasher.
- Under certain conditions, hydrogen gas may be produced in a hot water system that has not been used for two weeks or more. **HYDROGEN GAS IS EXPLOSIVE.** If the hot water system has not been used for such a period, before using the dishwasher turn on all hot water faucets and let the water flow from each for

several minutes. This will release any accumulated hydrogen gas. As the gas is flammable, do not smoke or use an open flame during this time.

- Remove the door to the washing compartment when removing an old dishwasher from service or discarding it.
- For a grounded, cord connected dishwasher:

GROUNDING INSTRUCTIONS

The dishwasher must be grounded. In the event of a malfunction or breakdown, grounding will reduce the risk of electrical shock by providing a path of least resistance for electric current. The dishwasher is equipped with a cord having an equipment-grounding conductor and a grounding plug. The plug must be plugged into an appropriate outlet that is installed and grounded in accordance with all local codes and ordinances.

WARNING – Improper connection of the equipment-grounding conductor can result in a risk of electrical shock. Check with a qualified electrician or service representative if you are in doubt whether the dishwasher is properly grounded. Do not modify the plug provided with the dishwasher; if it will not fit the outlet, have a proper outlet installed by a qualified electrician.

- For a permanently connected dishwasher:

GROUNDING INSTRUCTIONS

The dishwasher must be connected to a grounded metal, permanent wiring system, or an equipment-grounding conductor must be run with the circuit conductors and connected to the equipment-grounding terminal or lead on the dishwasher.

– SAVE THESE INSTRUCTIONS –

Parts and Features

Your dishwasher is illustrated below with the parts and features called out. To help you find information on specific parts or features quickly, page references are included.

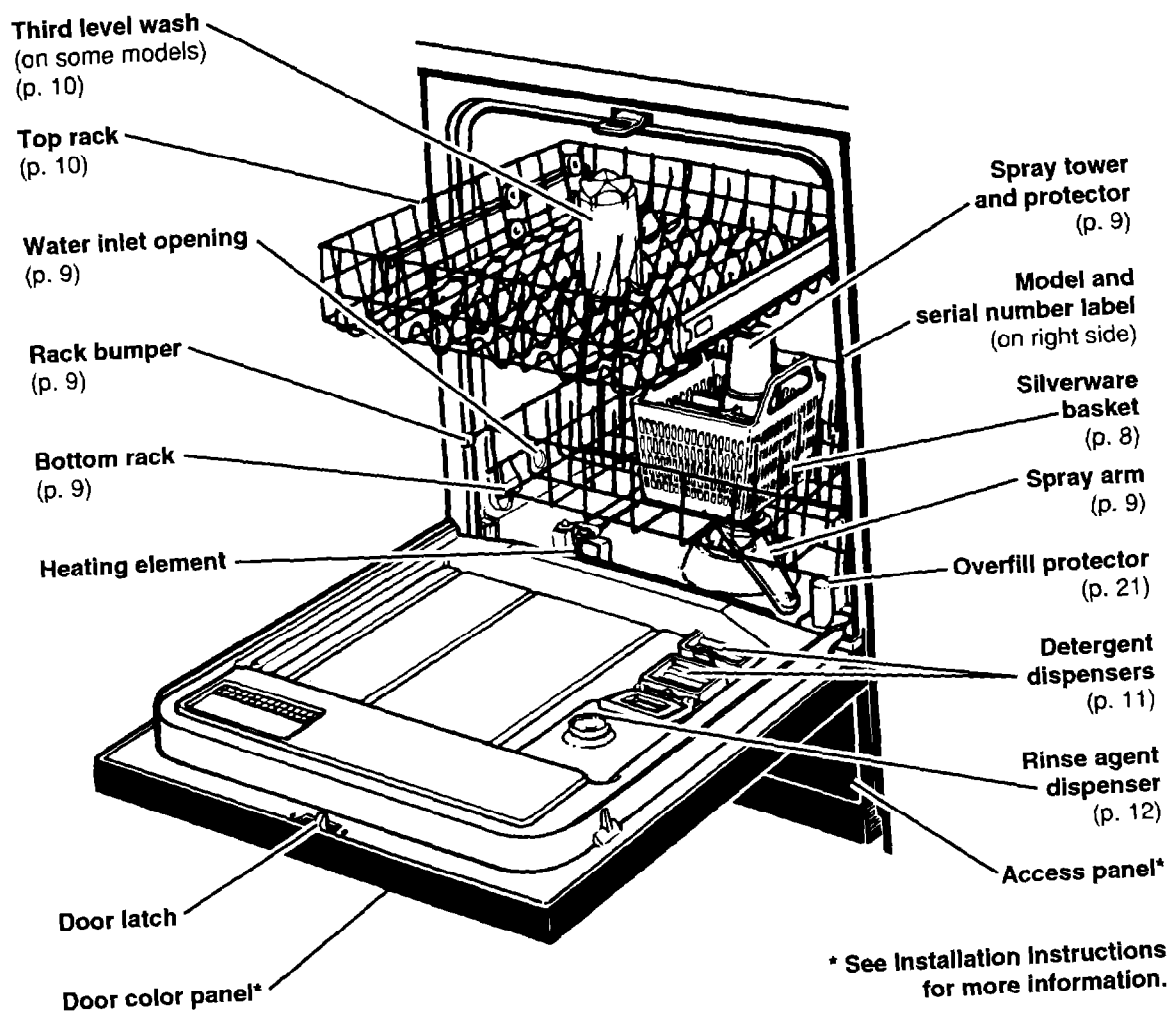

Series 400 models

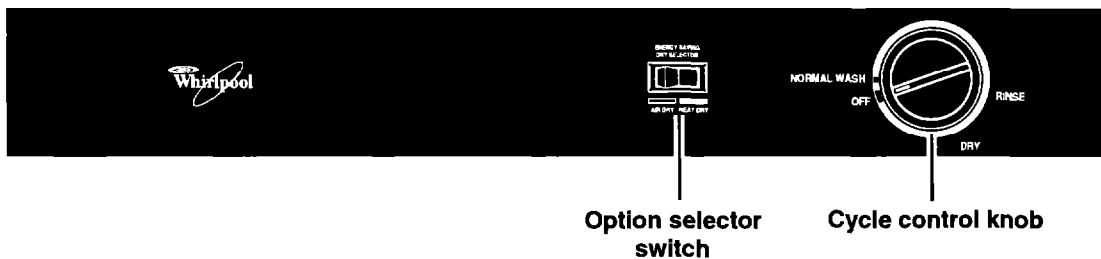

Series 800 and 806 models



Series 810 models

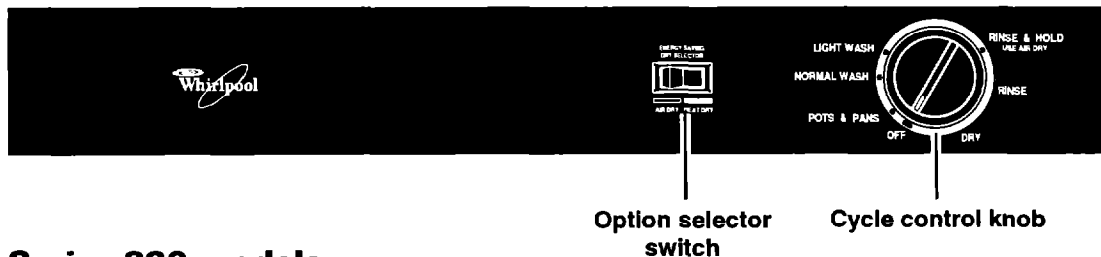

Series 830 models



Series 840 models

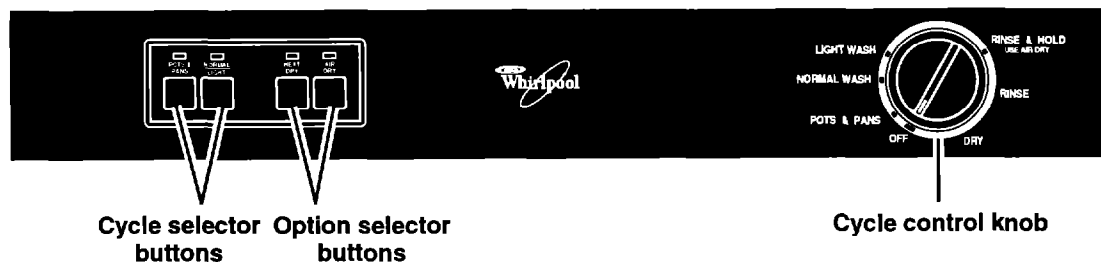

Starting Your Dishwasher

This section tells you how to start or stop your dishwasher. Refer to it for quick reference.

Before You Use Your Dishwasher

⚠ WARNING

<p>Tip Over Hazard Do not use dishwasher until completely installed. Do not push down on open door. Doing so can result in serious injury or cuts.</p>

⚠ WARNING

<p>Electrical Shock Hazard Electrically ground dishwasher. Connect ground wire to green ground connector in terminal box. Do not use an extension cord. Failure to do so can result in death, fire, or electrical shock.</p>

STARTING YOUR DISHWASHER

1. Load the dishwasher. See the "Loading Your Dishwasher" section.



2. Spin the spray arm. It should turn freely.



3. Add detergent. See the "Using the Dispensers" section.



4. Add rinse agent, if needed.

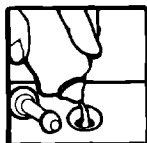

5. Close door firmly until it latches.

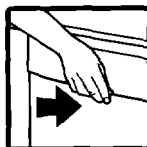

6. Run hot water at the sink nearest the dishwasher until water is hot. Turn off water.

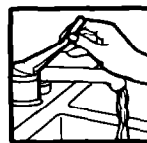

7. Select a drying option. (See the "Setting the Controls" section.) For models with buttons, the indicator above the button will show red when the option has been selected. For models with rocker switches, the switch indicates which option has been selected.

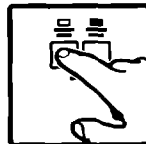

NOTE: Select Air Dry for the Rinse & Hold cycle. For Series 840 models, push a Cycle button for the desired cycle. Normal Wash, Light Wash, and Rinse & Hold cycles share the same button. The Cycle Control Knob determines which cycle operates. For Series 830 models, the Heat Dry option is automatically selected with the Pots & Pans cycle.

8. Turn the Cycle Control Knob clockwise to the desired cycle. You will feel a definite "stop" at each cycle mark. The dishwasher automatically starts the cycle you select.

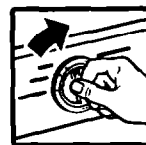

NOTE: If the door is latched, you will hear the cycles start and stop as the control knob passes each cycle mark. This is normal and does not hurt the dishwasher. If you prefer, you can set the Cycle Control Knob with the door unlatched.

Stopping the dishwasher

You can stop your dishwasher anytime during a cycle. All you have to do is:

- Open the door slightly. Wait for any filling or spraying action to stop before opening the door all the way. Close the door to continue the cycle.

OR

- Turn the Cycle Control Knob slowly clockwise until you hear water draining. Let the dishwasher drain completely. Then open the door and turn the Cycle Control Knob to Off.

Loading Your Dishwasher

This section tells how to properly load your dishwasher for best washing and rinsing results.

Preparing to load your dishwasher

- To save water and energy, do not rinse dishes before putting them into the dishwasher.
- Remove large pieces of food, bones, and other hard items.
- Foods like eggs, rice, pasta, and cooked cereals may be hard to remove if left to dry over a period of time. Run a Rinse & Hold cycle to keep dishes moist if you do not plan to wash them soon.
- Load dishes so soiled surfaces face the rotating spray arm.
- Load dishes so they are not stacked or overlapping. It is important for the water spray to reach all soiled surfaces for best washing. For best drying, water must be able to drain from all surfaces.

Loading for quiet operation

- Secure lightweight load items in the racks.
- Pot lids and handles, pizza pans, cookie sheets, etc., should not touch interior walls, interfere with the spray arm's rotation, or cover the spray tower.
- Load dishes so they do not touch one another.

NOTE: Keep sink drain plugs inserted during dishwasher operation to prevent noise transfer through drains.

Loading the silverware basket

- Load the silverware basket while it is in the bottom rack or take the basket out for loading on a counter or table.

NOTE: The loaded basket must be placed in the center front (over the spray tower) of the bottom rack for proper washing.



- Mix items in each section of the basket with some pointing up and some down to avoid nesting. Spray cannot reach nested items.

IMPORTANT: Always load sharp items (knives, skewers, forks, etc.) pointing down.

- Put small items (baby bottle caps, jar lids, etc.) in any section.
- You can also remove the basket for easy unloading. Always unload or remove the basket before unloading the racks to avoid spilling water on the silverware.

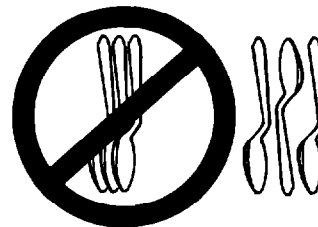

Loading the bottom rack

Load items with cooked-on or dried-on food in the bottom rack, with soiled surfaces facing inward to the spray.

Mixed load

- Load plates, soup bowls, etc., between prongs and facing inward to the spray.
- Make sure pot handles and other items do not stop rotation of the spray arm. Spray arm must move freely.
- Load items so they do not block or cover the spray tower.
- Load heavily soiled cookware face down in rack.
- Do not stack or overlap dishes. Water spray must reach all soiled surfaces for best results.

Utensil load

- Load cookie sheets, cake pans, and other large items at sides and back. Loading such items in front may keep water spray from reaching detergent dispenser and silverware basket.

NOTES:

- Do not load glasses, cups, or plastic items in the bottom rack.
- Do not load items between the bottom rack and the dishwasher tub. This can block the water inlet opening.
- If you have removed the bottom rack for unloading or cleaning, replace it with bumpers in front.

Mixed load

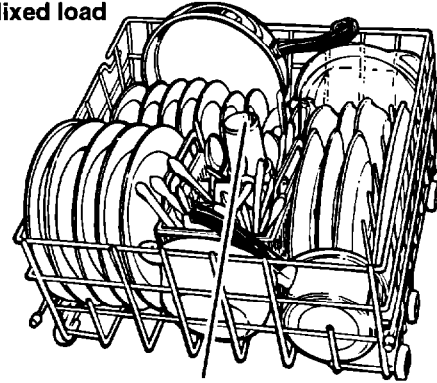

Do not cover spray tower

Utensil load

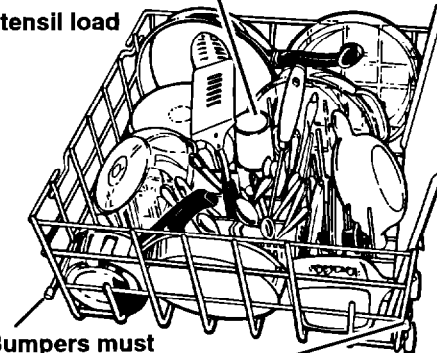

Bumpers must face dishwasher door

Loading the top rack

Load the top rack with cups, glasses, and smaller items. Do not cover the third level wash (on some models) when loading the top rack.

Cup and glass load

- Load so open ends face down for cleaning and draining.
- Load glasses in top rack only – bottom rack is not designed for glasses. Damage can occur.
- Place items in the rows **between** prongs. Placing them over the prongs may lead to breakage.
- Secure lightweight items.
- China, crystal, and other delicate items must not touch each other during dishwasher operation. Damage may occur.

Mixed load

- Small bowls, pans, and other utensils can be placed in the top rack.
- Load plastic items in the top rack only. Plastic items may melt in the bottom rack.
- Wash only plastic items marked “dish-washer safe.”
- Load plastic items so the force of the spray does not move them during the cycle.

Cup and glass load

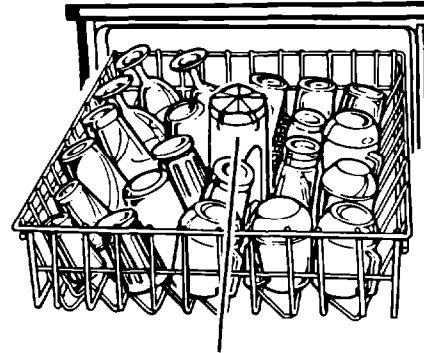

Do not cover third level wash
(on some models)

Mixed load



Using the Dispensers

For best washing results, review the information below. It is important to use detergents and rinse agents properly.

Using the detergent dispenser

- Use automatic dishwashing detergent **only**. Other detergents are too mild and much too sudsy.
- Add detergent just before starting cycle.
- Store detergent tightly closed in a cool, dry place. **Fresh automatic dishwasher detergent results in better cleaning.**

Filling the detergent dispenser

The detergent dispenser has one section with a cover and one without. Push cover down firmly until it latches. Detergent in the open section falls into the dishwasher when closing the door. The covered section opens automatically for the main wash.

NOTE: It is normal for the cover to open partially when dispensing detergent.

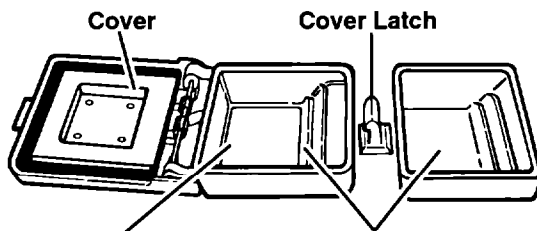

Use only covered section for:
– Light Wash*

Use both sections for:
– Normal Wash
– Pots & Pans*

* Cycle on some models only.

How much detergent to use

- The amount of detergent to use depends on the hardness of your water and the type of detergent. If you use too little, dishes won't be clean. If you use too much in soft water, glassware will etch.
- Different brands of dishwasher detergent have different amounts of phosphorus for softening water. If you have hard water and use low phosphorous content detergent (6.0% or less), you may need to use more detergent or use a detergent with a higher phosphorous content (8.7%).
- Find out your water's hardness by asking your local water department, water softener company, or county extension agent.

WATER TYPE	WHERE TO FILL	
Hard 8+ grains per gallon 136+ parts per million	Top of 3rd step (3 tbs)	
Medium 5-7 grains per gallon 85-119 parts per million	Top of 2nd step (2 tbs)	
Soft 0-4 grains per gallon 0-68 parts per million	Top of 1st step (1 tbs)	

Fill amounts shown are for standard powdered detergent. Amounts may vary if you use liquid or concentrated powdered detergent. Follow manufacturer's directions when using liquid dishwasher detergent or concentrated powdered detergent.

USING THE DISPENSERS

Using the rinse agent dispenser

Keep the rinse agent dispenser filled with a liquid rinse agent. **A rinse agent greatly improves dish drying by helping water flow off during the last rinse.** A rinse agent also keeps water from forming droplets and drying as spots or streaks.

A small amount of rinse agent automatically releases into the rinse water during the final rinse of each cycle. **For best drying results, check dispenser periodically to see if it needs filling.**

To check dispenser:

- Check center of Fill Indicator Cap. Clear means it needs filling.
- OR**
- Remove Fill Indicator Cap. An “E” is visible when dispenser is empty.

To fill dispenser:

The rinse agent dispenser holds 6 ounces (175 mL). Under normal conditions, this lasts about 3 months.

1. Open dishwasher door completely.
2. Remove Fill Indicator Cap.
3. Add rinse agent. Fill to smallest opening in lower part of dispenser only. Overfilling may cause rinse agent to leak out. This will not harm the dishwasher, but could cause oversudsing.
4. Clean up any spilled rinse agent with a damp cloth.
5. Replace Fill Indicator Cap. Keep it closed tightly.

NOTE: You do not have to wait until the dispenser is empty before refilling, but do not overfill it. Your dishwasher is designed to use a liquid rinse agent. You do not need to use a solid or bar-type rinse agent.

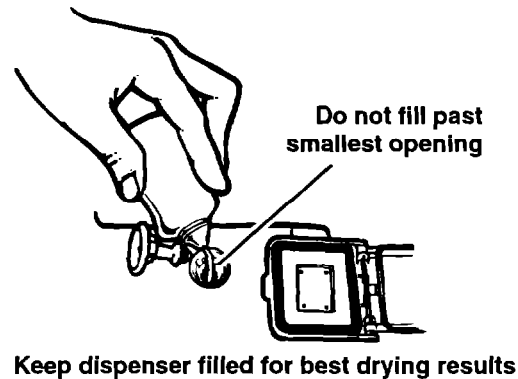
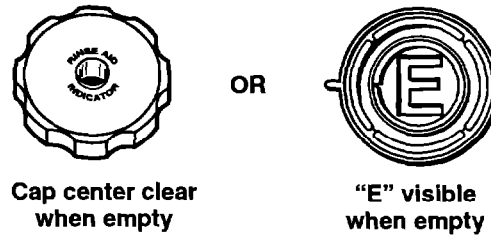

Setting the Controls

Operating your dishwasher's controls properly helps you obtain the best possible washing results. This section tells you how to select wash cycles and options.





Selecting a wash cycle

For Series 400, 800, 806, and 810 models:
Turn Cycle Control Knob to desired cycle.

For Series 830 models:
Press Pots & Pans button for that cycle. Or press either Heat Dry or Air Dry for Normal Wash and Light Wash cycles. Press Air Dry for Rinse & Hold cycle. Turn Cycle Control Knob to desired cycle.

For Series 840 models:
Press a cycle pad, then turn the Cycle Control Knob to desired cycle. Normal Wash, Light Wash, and Rinse & Hold all share the same cycle pad.

NOTE: Your model may have all or some of the cycles shown.

CYCLE	A "*" shows what each cycle includes							CYCLE TIME (Minutes)
	WASH	RINSE	RINSE	MAIN WASH	RINSE	FINAL RINSE	DRY	
POTS & PANS  Double wash for maximum cleaning of cooked-on or baked-on foods.	•	•	•	•	•	•	•	98*
NORMAL WASH  Double wash for normal, everyday soiled loads. (The Energy Guide label is based on this cycle.)	•		•	•	•	•	•	90*
LIGHT WASH  Single wash for prerinsed or lightly soiled loads.			•	•	•	•	•	85*
RINSE & HOLD  For rinsing a few items to be washed one or more days later. <ul style="list-style-type: none"> • Do not use detergent. • Use Air Dry option. 					•	•		20

* Cycle time includes dry time.

Canceling a cycle

You can cancel a cycle at any time.

1. Turn the Cycle Control Knob slowly clockwise until you hear water draining. Let the dishwasher drain completely.
2. Open the door.
3. Turn the Cycle Control Knob to Off.

Selecting cycle options

You can select a drying option after the dishwasher starts as long as the Cycle Control Knob has not reached Dry.

Heat Dry option

If the Heat Dry option is selected, air in the dishwasher is heated during the “dry” part of the cycle. For best results, use a liquid rinse agent.

For Series 830 models, the Heat Dry option is automatically selected with the Pots & Pans cycle.



Series 400, 800, 806, and 810 models

OR



Series 830 and 840 models

Air Dry option

When Air Dry is selected, the air in the dishwasher is not heated during the “dry” portion of a cycle. Using Air Dry helps save energy, but dishes take longer to dry and some spotting can occur. Some items (such as plastics) may need towel drying. For best drying, use a liquid rinse agent.

NOTE: You must choose either Air Dry or Heat Dry for each wash cycle. Select Air Dry when using the Rinse & Hold cycle (Series 800, 806, 810, 830, and 840 models).



Series 400, 800, 806, and 810 models

OR



Series 830 and 840 models

Changing a cycle setting

(on some models)

You can change a cycle setting anytime during any cycle.

1. Lift up the door latch to stop the cycle.
2. Turn the Cycle Control Knob clockwise to the desired cycle.
3. Check the detergent dispensers. They must be filled properly for the new cycle.

NOTE: Turning the Cycle Control Knob can cause the covered section of the detergent dispenser to open and release the detergent. Check the covered section if setting Normal Wash or Pots & Pans cycle.

4. Close the door firmly until it latches. The dishwasher starts the new cycle.

Adding an item during a cycle

(on some models)

You can add an item to the dishwasher anytime before the Cycle Control Knob reaches Light Wash. Items added after the Cycle Control Knob reaches Light Wash will only be rinsed.

1. Lift up the door latch to stop the cycle. Wait for spraying action to stop before opening the door.
2. Open the door and add the item.
3. Close the door, but **do not** latch it. Wait 30 seconds for the air in the dishwasher to warm up. Doing so reduces the amount of moisture in the vent when restarting a cycle.
4. Close the door firmly until it latches. The dishwasher resumes the cycle.

Washing Special Items

If you have any doubts about washing a particular piece of dishware, check with the manufacturer to see if it is dishwasher safe.

MATERIAL	DISHWASHER SAFE?	EXCEPTIONS/SPECIAL INFORMATION
Aluminum	Yes	High water temperature and detergents can pit finish of anodized aluminum.
Bottles and Cans	No	Wash bottles and cans by hand. Labels attached with glue can loosen in your dishwasher. Loose labels and glue can clog spray arm or the pump and will reduce washing performance.
Cast Iron	No	Seasoning will be removed and iron will rust.
China/ Stoneware	Yes	Always check manufacturer's recommendations before washing. Antique, hand-painted, or over-the-glaze patterns may fade. Gold leaf can discolor or fade.
Crystal	Yes	Always check manufacturer's recommendations before washing. Some types of leaded crystal can etch with repeated washings.
Gold	No	Gold-colored flatware will discolor.
Glass	Yes	Milk glass will yellow with repeated dishwasher washing.
Hollow-Handle Knives	No	Handles of some knives are attached to the blade with adhesives which may loosen if washed in the dishwasher.
Pewter	No	High water temperatures and detergent can discolor or pit finish.
Disposable Plastics	No	Cannot withstand high water temperatures and detergents.
Plastics	Yes	Always check manufacturer's recommendations before washing. Plastics vary in their capacity to withstand high water temperatures and detergents. Load plastics in top rack only.
Stainless Steel	Yes	Run the Rinse & Hold cycle if not washing immediately. Prolonged contact with food containing salt, vinegar, milk products, or fruit juice can damage finish.
Sterling Silver or Silver Plate	Yes	Run the Rinse & Hold cycle if not washing immediately. Prolonged contact with food containing salt, acid, or sulfide (eggs, mayonnaise, and seafood) can damage finish.
Tin	No	Can rust.
Wooden Ware	No	Always check manufacturer's recommendations before washing. Untreated wood can warp, crack, or lose its finish.

Connecting a Portable Dishwasher

Electrical connection

⚠ WARNING



Electrical Shock Hazard

Plug into a grounded 3 prong outlet.

Do not remove ground prong.

Do not use an adapter.

Do not use an extension cord.

Failure to follow these instructions can result in death, fire, or electrical shock.

A power supply of 120 volts, 60Hz AC, 15 or 20 amps, is required. For your personal safety, this appliance must be grounded. This appliance is equipped with a power supply cord having a 3-prong grounding plug. To minimize possible shock hazard it must be plugged into a mating 3-prong grounding type wall receptacle, grounded in accordance with the National Electrical Code and local codes and ordinances. If a mating wall receptacle is not available, it is the responsibility and obligation of the customer to have a properly grounded 3-prong wall receptacle installed by a qualified electrician.

NOTE: A special adapter must be installed on the faucet before the dishwasher can be connected. Complete instructions and the adapter are packed with your dishwasher.

When moving your dishwasher make sure the door is latched. Hold the dishwasher at the top front corners.

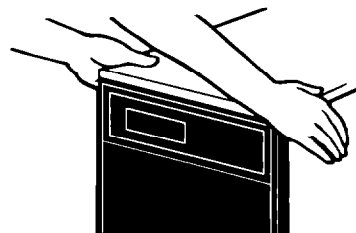
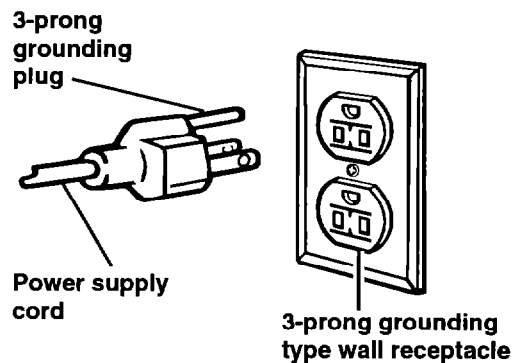

CONNECTING A PORTABLE DISHWASHER

Connecting the dishwasher

1. Run water at faucet until it is hot. Turn water off.
2. Pull hoses out of their storage compartment on the back of the dishwasher.

NOTE: Make sure the hoses are not kinked or twisted. Kinked hoses reduce washing performance.

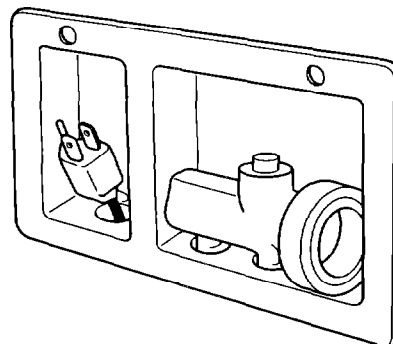

3. Pull down on the locking collar while lifting the hose connector onto the faucet adapter.
4. When the connector snaps into place, release the locking collar.
5. Turn the hot water on slowly until it is all the way on.
6. Plug in power supply cord.
7. See the "Starting Your Dishwasher" section for instructions on how to start the dishwasher.

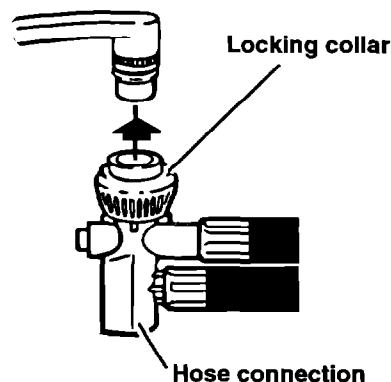

Drawing water when dishwasher is connected

You can draw water from the faucet while the dishwasher is connected. **Do not** draw water while the dishwasher is filling or while water is being pumped out. (This helps prevent a low fill when dishwasher is filling or mixing drain water with fresh water.)

- Press the red button on the hose connector to draw water from faucet. (The faucet is set on hot. Adjust faucet for the water temperature you want.)

NOTE: Turn hot water back on after you draw water from faucet. Turn off cold water.

CONNECTING A PORTABLE DISHWASHER

Disconnecting the dishwasher

1. Turn hot water off. (This can be done after the last rinse.)
2. Press the red button on the connector to release the water pressure.
3. Lift slightly on the hose connector while pulling down the locking collar. Pull down on the connector.
4. Empty any remaining water from the connector by turning the connector upside down.
5. Unplug power supply cord and return to storage compartment.
6. Return hoses to storage compartment.

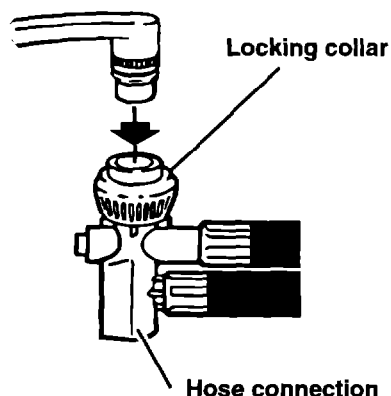

Converting a portable dishwasher to a built-in

Your WHIRLPOOL® Portable Dishwasher can be converted to a built-in (undercounter) model by using conversion kit No. 4317856. The kit is available at your Whirlpool dealer or authorized Whirlpool service company. Instructions are included with the kit.

Caring for Your Dishwasher

Your new dishwasher is designed to give you many years of dependable service. There are a few things you can do to maintain your dishwasher properly. This section tells you how to clean and care for your dishwasher. Refer to the "Solving Common Dishwasher Problems" section for special cleaning problems. See Installation Instructions for information on storing your dishwasher and for cleaning the drain air gap.

Caring for simulated wood top (on portable models)

The simulated wood top can be used as a utility work surface for most kitchen jobs. It is stronger and more easily cleaned than genuine wood. The top can be used as a cutting board. Knife marks will be visible, but will not seriously damage top. Hot items from the oven can be placed on the top. Clean top with warm, soapy water. For dried-on foods, use a scouring pad.

Cleaning the exterior

In most cases, regular use of a soft, damp cloth or sponge and a mild detergent is all that is necessary to keep the outside of your dishwasher nice looking and clean.

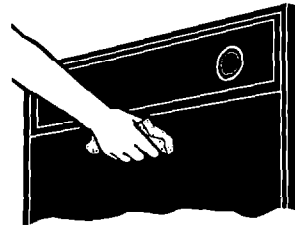

Cleaning the interior

Hard water minerals may cause a white film to build up on the inside surfaces, especially just beneath the door area. To clean interior:

- Apply powdered dishwasher detergent to a damp sponge to make a paste.

OR

- Use liquid automatic dishwasher detergent and clean with damp sponge.

Do not clean the dishwasher interior until it has cooled.

Wear rubber gloves. **Do not** use any type of cleanser other than dishwasher detergent because it can cause foaming or sudsing.

NOTE: See “Removing spots and film” in the Solving Common Dishwashing Problems section to clean your dishwasher with white vinegar. Remember, this procedure is intended for occasional use only. Vinegar is an acid. Excessive use can damage your dishwasher.

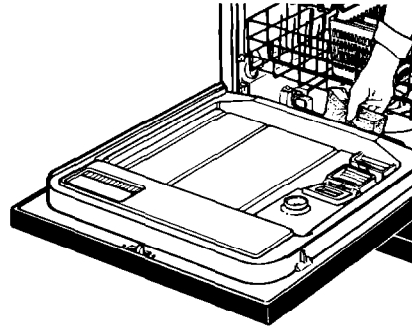

Overfill protector

The overfill protector (in the front right corner of the dishwasher tub) keeps the dishwasher from overfilling. It must be in place for the dishwasher to operate.

Check under the float for objects that may keep the protector from moving up or down.

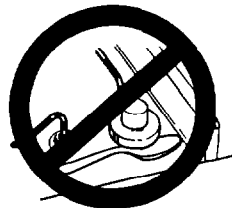

Cleaning the filter screen

The filter system requires periodic cleaning as needed. To clean screen:

1. Unload and slide the bottom rack forward. (Remove bottom rack if necessary to reach filter screen.)
2. Remove collected particles from the screen with your fingers or paper towel.
3. Return the bottom rack to original position.

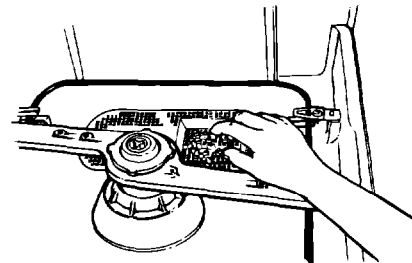

Storing your dishwasher

Moving or winterizing your dishwasher

Protect your dishwasher and home against water damage due to freezing water lines. If your dishwasher is left in a seasonal dwelling or could be exposed to near freezing temperatures, have a qualified person do the following:

NOTE: Pump motor styles vary by model. Refer to Figure 1 or Figure 2, depending on the style of your dishwasher.

1. Disconnect power supply to the dishwasher.
2. Turn off water supply to the dishwasher.
3. Remove the 4 screws on the lower access panel and remove the lower access panel.
4. Place a shallow pan under the water supply valve. Then, use a wrench to disconnect the water inlet from the water supply valve. Separate the water inlet from the water supply valve and drain water into the pan.
5. Remove the spring clamp from the water outlet and separate from the water supply valve; drain water into pan.
6. Reconnect both water inlet and water outlet to the water supply valve.
7. Empty the pan and reposition it under the water pump.
8. Remove the clamp and disconnect the drain hose from the water pump; drain water into pan.
9. Reconnect drain hose to the water pump, being sure to position the clamp over the connection.
10. Replace the lower access panel.

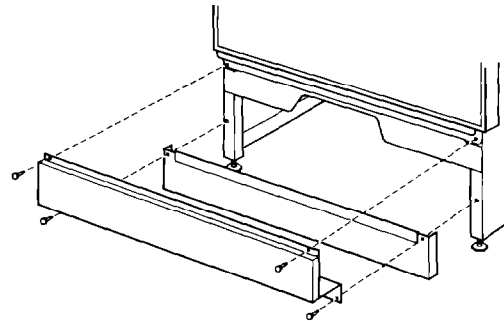

Figure 1

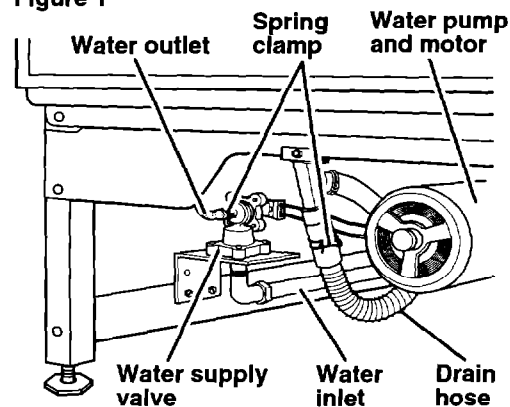
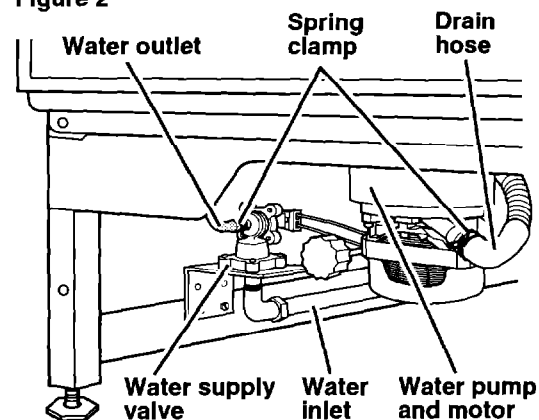

Figure 2



NOTE: If your dishwasher is connected to a garbage disposal, do not run water into the sink after winterizing. This could cause water to refill the drain hose on your dishwasher.

Reconnecting your dishwasher

1. Remove the 4 screws on the lower access panel and remove lower access panel.
2. Turn on the water supply to dishwasher.
3. Turn on power supply to dishwasher.
4. Run dishwasher through a complete cycle and check for leaks.
5. Replace lower access panel.

Storing for the summer

Protect your dishwasher during the summer months by turning off the water supply and power to the dishwasher.

Saving Energy

Saving energy is important and helps you save money. This section gives you tips on the best ways to save energy with your dishwasher.

Loading tips

- Wash full loads. Running a half-filled dishwasher uses the same amount of electricity and hot water as a fully loaded machine.
- Load correctly for best washing results. Incorrect loading may cause poor washing and the need to rewash all or part of load.
- Do not prerinse normally soiled dishes. Select the correct cycle for the load and use the recommended amount of detergent.

Cycle and option tips

- If your model has the Light Wash cycle, use it whenever possible. The cycle uses less hot water and energy than the Normal Wash cycle.
- Run your dishwasher during off-peak hours. Local utilities recommend avoiding heavy usage of energy at certain times of day.
- Use the Air Dry option whenever possible. Allow longer drying times (overnight). Use a rinse agent to improve drying.
- Loads may not wash or dry as well if the water temperature is too low. For best dishwashing results, water must be at least 120°F (49°C) as it enters the dishwasher.

To check water temperature:

1. Run the hot water at the faucet closest to your dishwasher. Let the water run for at least 1 minute.

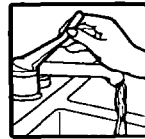

2. Hold a candy or meat thermometer in the running stream of water. If the water temperature at the faucet is below 120°F (49°C), have a qualified person raise the water heater's thermostat setting.

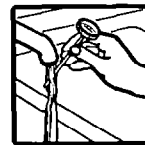

Solving Common Dishwashing Problems

A convenient checklist for handling minor performance problems. Go over this list before calling for service. If you are unable to solve your dishwasher's problem, turn to the "Troubleshooting" section for service information.

Solution chart

PROBLEM	CAUSE	SOLUTION
Food soil left on dishes	Improper loading	Follow loading instructions.
	Water temperature too low	If needed, turn home water heater up to ensure water entering dishwasher is 120°F (49°C) minimum. See the "Saving Energy" section.
	Use of incorrect, too little, or ineffective detergent	Use recommended dishwasher detergents only. See the "Using the Dispensers" section. Never use less than 1 tablespoon per load. Detergent must be fresh to be effective. Always store detergent tightly closed in a cool, dry place.
	Detergent cakes in dispenser	Use fresh detergent only. Do not allow detergent to sit for several hours in a wet dispenser. Check dispenser for caked detergent. Clean dispenser when caked detergent is present.
	Insufficient fill due to low water pressure	Home water pressure should be 20 to 120 pounds per square inch (psi) for proper dishwasher fill. A booster pump on the water supply may be necessary if pressure is too low.
	Slowdown of wash arm due to high suds	Never use soap or laundry detergents. Use recommended dishwasher detergents only.
Spotting and filming	Hard water or high mineral content in water	Use rinse agent to help prevent spotting and filming. See the "Using the Dispensers" section. To remove hard water film, see "Removing spots and film" at the end of this section.
	Water temperature too low	If needed, turn home water heater up to ensure water entering dishwasher is 120°F (49°C) minimum.
	Use of incorrect detergents	Use recommended dishwasher detergents only.

continued on next page

SOLVING COMMON DISHWASHING PROBLEMS

PROBLEM	CAUSE	SOLUTION
Spotting and filming (continued)	Incorrect amount of detergent	Follow recommendations for amount. Heavy soil and/or hard water generally require extra detergent.
	Use of ineffective detergents	Use fresh detergent. Store detergent tightly closed in a cool, dry place. Discard lumpy detergent.
	Insufficient fill due to low water pressure	Home water pressure should be 20 to 120 psi for proper dishwasher fill. A booster pump on the water supply may be necessary if pressure is too low.
Dishes do not dry completely	Dishes do not drain properly	Dishes must have proper water drainage. Do not overload. See the "Loading Your Dishwasher" section. Use a liquid rinse agent to speed draining.
	Plastics	Some plastics, due to material, may need to be towel dried.
Silica film or etching (silica film is a white iridescent deposit; etching is a cloudy film)	Water chemical reaction with certain types of glassware – usually caused by some combination of soft or softened water, alkaline washing solutions, insufficient rinsing, overloading the dishwasher, and heat of drying.	It may not be possible to prevent problem, except by hand washing. To slow this process, use a minimum amount of detergent but not less than 1 tablespoon per load. Use a liquid rinse agent and underload the dishwasher to allow thorough rinsing. Silica film and etching are permanent and cannot be removed. Use the Air Dry option.
Black or gray marks on dishes	Aluminum items touching dishes	Load aluminum items so that they will not rub against dishes during washing. Do not wash throwaway aluminum items in the dishwasher because they may break down and cause marking. Remove aluminum markings by using a mild abrasive cleanser.
White spots on cookware with non-stick finish	Seasoning removed by dishwasher detergents	Reseason cookware after dishwasher washing.

SOLVING COMMON DISHWASHING PROBLEMS

PROBLEM	CAUSE	SOLUTION
Brown stains on dishes and dishwasher interior	High iron content in water supply	Remove by washing dishes (after food soil has been removed) with 1 teaspoon to 1 tablespoon of citric acid crystals added to covered section of detergent dispenser. Do not use detergent. Follow with a Light Wash cycle and detergent. If treatment is needed more often than every other month, we recommend installation of an iron removal unit.
Orange stains on dishwasher interior	Large amounts of tomato-based foods on dishes placed in the dishwasher	Stains will not affect dishwasher performance and can gradually fade over time. Regular use of Rinse & Hold reduces the chance of staining. If air in the dishwasher is heated during the "dry" portion of the cycle, stains may fade slower than if the Air Dry option is selected.
Odor in the dishwasher	Dishes only washed every 2-3 days	Run a Rinse & Hold cycle at least once or twice a day until a full load is accumulated.
Chipping of dishes	Improper loading	Load dishes and glasses so they are stable and do not strike together from washing action. Moving racks in and out slowly will also minimize chipping. NOTE: Some types of china and glassware are too delicate for automatic dishwashing and should be hand washed; for example: antiques, feather-edged crystal, and similar items.

Removing spots and film

Keep the rinse agent dispenser filled with a liquid rinse agent. A rinse agent prevents water from forming droplets and drying as spots or streaks.

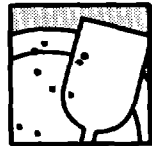

To remove spots and film on dishes and glasses, or hard water film/lime buildup on the interior of the dishwasher, you may use white vinegar with the following procedure:

1. Load clean dishes and glasses in dishwasher. Do not load silverware or other metals in the dishwasher.

2. Put 2 cups of household vinegar (in a glass or dishwasher safe measuring cup) standing upright in the bottom rack.
3. Close and latch the door.
4. Select the Normal Wash cycle and Air Dry option. Do not use detergent. Allow the dishwasher to complete the entire cycle.

NOTE: This cleaning procedure is intended for occasional use only. Vinegar is an acid. Excessive use may damage your dishwasher.

Troubleshooting

Before calling for assistance please check the chart below for problems you can fix. It could save you the cost of a service call.

Dishwasher problems

PROBLEM	CHECK THE FOLLOWING
Dishwasher does not run or stops during a cycle	<p>Is the door tightly closed and securely latched?</p> <p>Has the cycle been set correctly? See the "Setting the Controls" section.</p> <p>Has a household fuse blown or circuit breaker tripped?</p> <p>If the motor stopped because of an overload, it will automatically reset itself within a few minutes. If it does not start, call for service.</p> <p>Is the water supply turned on?</p>
Dishwasher will not fill	<p>Is the overfill protector stuck in "up" position? Overfill protector should move up and down freely. Press down to release. See the "Caring for Your Dishwasher" section.</p>
Water remains in dishwasher	<p>Allow cycle to finish. A small amount of water remaining is normal.</p> <p>Check the drain air gap (if installed). If it is clogged, follow the manufacturer's cleaning instructions.</p>
Detergent remains in covered section of dispenser	<p>Has the cycle completed?</p> <p>Is the detergent fresh and dry without lumps? See the "Using the Dispensers" section.</p> <p>Is the bottom rack in backwards? The rack bumpers must face the dishwasher door.</p>
Dishes not as dry as you expected	<p>Is the rinse agent dispenser empty? Using a rinse agent greatly improves drying. See the "Using the Dispensers" section.</p> <p>Do not use Air Dry option on the next load. See the "Setting the Controls" section.</p>
White residue appears on front of access panel	<p>Is too much detergent being used? See the "Using the Dispensers" section.</p> <p>Some liquid detergents develop excess foam and residue on panel. Try a different brand to reduce foaming and eliminate buildup.</p>
Dishwasher will not close	<p>Is the bottom rack in backwards? The rack bumpers must face the dishwasher door.</p>

Requesting Assistance or Service

Before calling for assistance or service, please check the "Troubleshooting" section. It may save you the cost of a service call. If you still need help, follow the instructions below.

1. If you need assistance* ...

Call the Whirlpool Consumer Assistance Center telephone number. Dial toll-free from anywhere in the U.S.A.:



1-800-253-1301

and talk with one of our trained consultants. The consultant can instruct you in how to obtain satisfactory operation from your appliance or, if service is necessary, recommend a qualified service company in your area.

If you prefer, write to:

Whirlpool Brand Home Appliances
Consumer Assistance Center
c/o Correspondence Dept.
2000 North M-63
Benton Harbor, MI 49022-2692

Please include a daytime phone number in your correspondence.

2. If you need service* ...

Whirlpool has a nationwide network of authorized service companies. Whirlpool service technicians are trained to fulfill the product warranty and provide after-warranty service, anywhere in the United States. To locate the authorized Whirlpool service company in your area, call our Consumer Assistance Center telephone number (see Step 1) or look in your telephone directory Yellow Pages under:



• APPLIANCE-HOUSEHOLD-MAJOR, SERVICE & REPAIR

- See: Whirlpool Appliances or Authorized Whirlpool Service (Example: XYZ Service Co.)

• WASHING MACHINES & DRYERS, SERVICE & REPAIR

- See: Whirlpool Appliances or Authorized Whirlpool Service (Example: XYZ Service Co.)

3. If you need FSP® replacement parts ...

FSP is a registered trademark of Whirlpool Corporation for quality parts. Look for this symbol of quality whenever you need a replacement part for your WHIRLPOOL® appliance. FSP replacement parts will fit right and work right, because they are made to the same exacting specifications used to build every new WHIRLPOOL appliance.

To locate FSP replacement parts in your area, refer to Step 2 or call the Whirlpool Consumer Assistance Center number in Step 1.

4. If you are not satisfied with how the problem was solved ...

- Contact the Major Appliance Consumer Action Program (MACAP). MACAP is a group of independent consumer experts that voices consumer views at the highest levels of the major appliance industry.
- Contact MACAP only when the dealer, authorized servicer, and Whirlpool have failed to resolve your problem.

Major Appliance Consumer Action Program
20 North Wacker Drive
Chicago, IL 60606

- MACAP will in turn inform us of your action.

* When asking for help or service:

Please provide a detailed description of the problem, your appliance's complete model and serial numbers, and the purchase date. This information will help us respond properly to your request.

Index

This index is alphabetical. Look for the word or phrase you are interested in, then look for the page number.

TOPIC	PAGE	TOPIC	PAGE
BOTTOM RACK	9	LOADING	
CLEANING		Bottom rack	9
Exterior	20	Preparing to load	8
Interior	21	Silverware basket.....	8
COMMON WASHING PROBLEMS		Top rack	10
Solving	25-27	OPTIONS	14
CONNECTING A PORTABLE		OVERFILL PROTECTOR	21
DISHWASHER	17-19	PARTS/FEATURES	4-5
CYCLE		RESPONSIBILITIES	
Canceling	14	Owner	2
Selecting	14	RINSE AGENT	
DETERGENT		Using	12
Tips	11	SAFETY	3
Use chart	11	SERVICE	
DISHWASHER OPERATION		Parts	29
Adding an item during a cycle	15	Requesting	29
Changing a cycle setting	15	SILVERWARE BASKET	8
Starting	6, 7	SPECIAL ITEMS	
Stopping	7	Washing	16
DISPENSER		SPOTS/FILM	
Detergent	11	Removing	27
Rinse Agent	12	TOP RACK	10
ENERGY		TROUBLESHOOTING	28
Saving	24	WARRANTY	32
FEATURES/PARTS	4-5	WATER	
FILM/SPOTS		Checking temperature	24
Removing	27		

WHIRLPOOL®

Dishwasher Warranty

LENGTH OF WARRANTY	WHIRLPOOL WILL PAY FOR
FULL ONE-YEAR WARRANTY FROM DATE OF PURCHASE	FSP® replacement parts and repair labor to correct defects in materials or workmanship. Service must be provided by an authorized Whirlpool service company.
FULL TWENTY-YEAR WARRANTY FROM DATE OF PURCHASE	FSP replacement parts and repair labor for the DURAPERM™ tub and/or inner door should they fail to contain water due to defective materials or workmanship. Service must be provided by an authorized Whirlpool service company.
WHIRLPOOL WILL NOT PAY FOR	
<p>A. Service calls to:</p> <ol style="list-style-type: none"> 1. Correct the installation of the dishwasher. 2. Instruct you how to use the dishwasher. 3. Replace house fuses or correct house wiring or plumbing. <p>B. Repairs when dishwasher is used in other than normal, single-family household use.</p> <p>C. Pickup and delivery. This product is designed to be repaired in the home.</p> <p>D. Damage to dishwasher caused by accident, misuse, fire, flood, acts of God, or use of products not approved by Whirlpool.</p> <p>E. Repairs to parts or systems caused by unauthorized modifications made to the appliance.</p>	

3/96

WHIRLPOOL CORPORATION SHALL NOT BE LIABLE FOR INCIDENTAL OR CONSEQUENTIAL DAMAGES. Some states do not allow the exclusion or limitation of incidental or consequential damages, so this exclusion or limitation may not apply to you. This warranty gives you specific legal rights, and you may also have other rights which vary from state to state.

Outside the United States, a different warranty may apply. For details, please contact your authorized Whirlpool dealer.

If you need service, first see the "Requesting Assistance or Service" section of this book. After checking "Requesting Assistance or Service," additional help can be found by calling our Consumer Assistance Center telephone number, **1-800-253-1301**, from anywhere in the U.S.A.